

# The feature extraction based hypersampler in *Il grifo nelle perle nere*: a bridge between player and instrument paradigm

Marco Marinoni

Conservatory “G. Verdi” of Como  
marco.marinoni@virgilio.it

## ABSTRACT

This paper concerns the hypersampler implemented for my piece *Il grifo nelle perle nere* for piano and hypersampler, composed in 2008 and premiered during the 54<sup>th</sup> Venice Biennale’s International Festival of Contemporary Music, in the framework of XVII CIM – Colloquium on Music Informatics.

The hypersampler involves a real-time synthesis engine based on processes of feature extraction as an alternative to hyperinstruments’ physical control paradigm. Features are derived from the performance of a traditional musician on an acoustic instrument – a piano – and are used as a control for the mapping between the instantaneous power spectrum of the acoustic instrument’s sound output (the musical dynamics performed by the pianist) and real-time synthesis engine’s parameters.

## 1. INTRODUCTION

According to Tod Machover, the basic concept of a hyperinstrument is to take musical performance data in some form, to process it through a series of computer programs, and to generate a musical result. The hyperinstrument, in its most simple meaning, as it has been conceived for the first time in 1987 for the work *Valis*, is based on musical instruments able to provide a great variety of solutions that musicians play on the computer. The simplest method is through an instrument similar to an existing conventional one, such as a keyboard or a percussion. The hypersampler developed for *Il grifo nelle perle nere* implements a keyboard instrument that becomes hypertext of another keyboard instrument, the piano. The software environment has been entirely developed in Max/MSP.

The parameter that really interested for long time Machover’s research is rhythm. In a live performance, This can mean the musicians are required a greater precision than is normally demanded, or may involve a higher degree of rhythmic complexity, and the creation of delicate relations of synchronicity that would be difficult to play without the aid of computer. However, a theory behind the development of hyperinstruments should include

the potential for live performance. Even in its interactions with technology, music is an art that is based on performance and interpretation, so “the ‘brain’ of a hyperinstrument is the computer system that monitors musical data from the input instrument, redefines the controls on that instrument, and acts in accordance with its programmed musical knowledge”<sup>1</sup>. In this sense, in the piece that underpins this paper, the gestural expressiveness related to pianistic musical dynamics triggers a sonification of the interpretative data related to the materials specified in the score through a delicate process of feature extraction<sup>2</sup> aimed to the construction of a virtual instrument that is informed in real time by a traditional instrument while retaining its own identity and all the features of a musical instrument in its own right, including the permeability to interpretative data.

As Bullock stated, a hyperinstrument system based on feature extraction can “minimise the number of prosthetic elements, and provide a seamless sense of interaction for the performer where sound becomes both the source of control and the means of gaining auditory feedback. Using sound as a medium for interaction removes the requirement for sensors, switches and other physical controllers in order to convey gestural information and performer intention”<sup>3</sup>.

This approach is consistent with that proposed by Machover in pieces like *Sparkler* (2002), where Machover, Jehan and Fabio developed a hyperinstrument system (an acoustic instrument-plus-laptop combination) aimed to “expand the expressive power” of traditional instruments and performers by placing microphones within the orchestra to capture the acoustic sound of all the instruments, which was then analyzed with a laptop and

<sup>1</sup> T. Machover, *Hyperinstruments: A Progress Report*. Cambridge, MA, USA: MIT Press, 1992, p. 4.

<sup>2</sup> Feature extraction is intended as “a form of data processing that takes a set of values and returns amore compact representation of those values. The compact representation is called a feature, and the initial set of values could be referred to as the input vector. The process of feature extraction is a form of dimension reduction, because it involves the mapping of an input vector of dimension N onto an output scalar or vector that has dimensionality that is smaller than N”. J. Bullock, *Implementing audio feature extraction in live electronic music*, Ph. D. Thesis submitted in partial fulfillment of the requirements for the degree of Doctor of Philosophy, Birmingham Conservatoire, Birmingham City University, 2008, p. 46.

<sup>3</sup> J. Bullock, *op. cit.*, p. 17.

processed “to shape and manipulate a complex electronic ‘aura’ that was added live to the orchestral sound”<sup>4</sup>.

From an interpretive and perceptual point of view, the hypersampler can be regarded as a minimal (two units) Interconnected Musical Network (IMN) intended according to the definition proposed by Weinberg<sup>5</sup>, who states that “only by constructing electronic (or mechanical) communication channels among players can participants take an active role in determining and influencing, not only their own musical output, but also their peers’”. For example, consider a player who while controlling the pitch of his own instrument also continuously manipulates his peer’s instrument timbre. This manipulation will probably lead the second player to modify her play gestures in accordance with the new timbre that she received from her peer”<sup>6</sup>. Both the sensor-based (mechanical) and the feature-extraction-based (electronic) approaches are aimed to develop an interactive network (the hybrid double instrument called the hyperinstrument system) able to combine gestural characteristics of musical interpretation and real-time sound processing into a “constantly evolving collaborative musical product”<sup>7</sup>.

In 1992 Rowe<sup>8</sup> proposed two distinct models of interaction in live electronic music: systems based on *player paradigm*, which provide a musical presence with a personality and a behavior of its own and systems based on *instrument paradigm*, which extend and augment the human performance through direct response to input generated by the performer via sound or physical control. One possible way of overcoming the limitation of these two paradigms is represented by the sensor-based approach, which stands on the ground of most of the hyperinstruments, investigating the correlation between musical and physical gesture and sonic output through the use of sensors that can be attached to the acoustic instruments and/or performers, with their outputs scaled and routed into live controlled sound processing algorithms. In the sensor-based hyperinstrument systems, in which “a sensor converts physical energy into electricity in the machine, and may therefore be called the ‘sense organ’ of a system”<sup>9</sup>, physical performance gesture is closely coupled with the audio output in a piece but “availability of existing gestural controllers is limited and new controllers can be expensive or time-consuming to develop”<sup>10</sup>. In 2001 Jehan proposed a system developed in Max/MSP

combining audio feature extraction, timbral mapping and synthesis in the context of live electronics performance whereby “continuous changes in articulation and musical phrasing” lead to “highly responsive sound output”<sup>11</sup>. The system developed by Jehan included real time mapping of extracted sound features and sonification of re-scaled data in order to get completely new material generated by the performance on traditional instruments.

The research at the basis of the hypersampler started from the purpose of developing a hyperinstrument system intended as an IMN able to overcome the limitations of Rowe’s player-instrument paradigm: a hybrid instrument not including the sensor-based approach, developed following the *instrument-player continuum model* proposed by Bullock<sup>12</sup> in 2008 that extends Rowe’s player-paradigm and instrument-paradigm and takes account of Jehan’s approach to real-time synthesis engines based on the extraction of perceptual features.

The hypersampler includes a piano, a master keyboard (e.g. EDIROL PCR1) the computer and the technical equipment needed for the implementation of live-electronics.

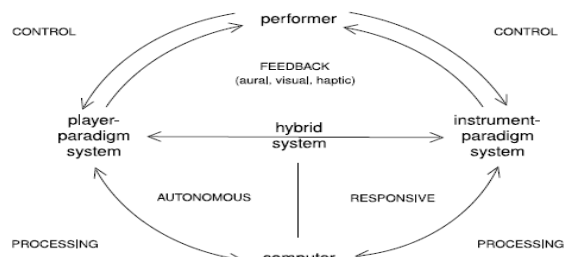

Figure 1. Bullock’s instrument-player continuum model.

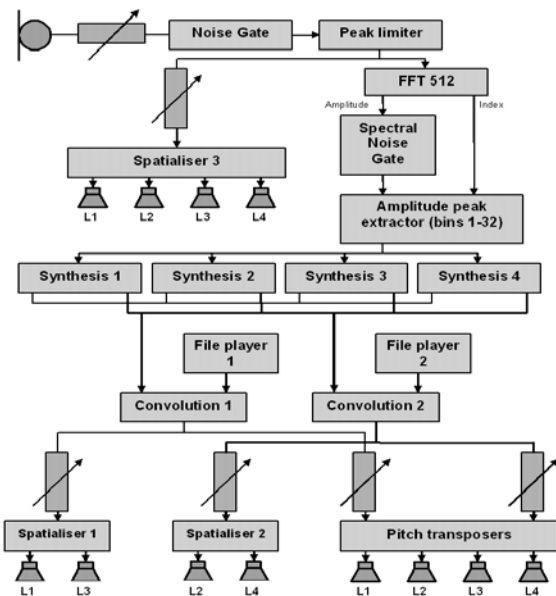

Figure 2. General overview of the hypersampler environment.

<sup>4</sup> T. Machover, *Dreaming a New Music*, in “Chamber Music”, Vol. 23 No 5 October 2006, pp. 46–54.

<sup>5</sup> Weinberg defines IMNs as “live performance systems that allow players to influence, share and shape each other’s music in real time”. G. Weinberg, *Interconnected Musical Networks – Bringing Expression and Thoughtfulness to Collaborative Group Playing*, Ph. D. Thesis submitted to the Program Media Arts and Sciences School of Architecture and Planning in partial fulfillment of the requirements for the degree of Doctor of Philosophy, Massachusetts Institute of Technology, 2003, p. 4.

<sup>6</sup> G. Weinberg, *op. cit.*, p. 22.

<sup>7</sup> G. Weinberg, *ibid.*

<sup>8</sup> R. Rowe, *Interactive music systems: machine listening and composing*, Cambridge, MA, USA: MIT Press, 1992.

<sup>9</sup> A. R. Jensenius, *Action — sound. Developing methods and tools to study music-related body movement*, Ph.D. thesis, Department of Musicology, University of Oslo, Oslo, Norway, 2007, p. 100.

<sup>10</sup> J. Bullock, *op. cit.*, p. 19.

<sup>11</sup> T. Jehan, *Perceptual synthesis engine: An audio-driven timbre generator*, Master’s thesis, Massachusetts Institute of Technology, 2001, p. 5.

<sup>12</sup> J. Bullock, *op. cit.*, p.16.

The instrumental signal is captured using three microphones, mixed according to different percentages in one monophonic signal and sent to the units of processing, which include: first stage of treatment by noise gate and peak limiter aimed to reduce the dynamic range and make the sound materials more easily treatable; second stage of treatment by processes of feature extraction (analytic level) and transformation of the data so obtained; third stage of treatment by synthesis (synthetic level), informed by the data coming from the previous stage; fourth stage of treatment by real-time convolution (the files *inscr\_convol\_1.wav* and *inscr\_convol\_2.wav* are included with the score) of output materials from the synthesis modules; finally, fifth stage of treatment by pitch transposers and sound projection by spatialising matrices controlled in real time by the hypersampler performer. The instrumental signal processed by first stage of treatment is projected (transparent amplification) too by matrices controlled in real time.

For the aims of this paper we will mainly focus on second and third stages of treatment, which form the hypersampler's engine.

*Il grifo nelle perle nere* was written in 2008 for the "Concerto per Ipertastiere" included in XVII CIM – Colloquium on Music Informatics. The first performance took place in Venice at the Concert Hall of Palazzo Pisani on Wednesday October 16<sup>th</sup> 2008 H 5pm, during the 54<sup>th</sup> Venice Biennale's International Festival of Contemporary Music, with the following performers: Davide Tiso, piano; Marco Marinoni, hypersampler; Alvisè Vidolin, sound direction.

## 2. HYPERSAMPLER'S ENGINE

In this chapter the typologies of sound processing are described, specifying the data and the variables essential for the realization of the hyperinstrument system. For each treatment the values of the parameters and their significance within the performance are indicated, identifying the ones intended to be controlled real-time by the live-electronics performer. Finally, it is provided information concerning the setting of the control surfaces according to correlation curves between parameter pairs and curves describing single parameters.

Jehan's assumption that "the timbre of a musical signal is characterized by the instantaneous power spectrum of its sound output"<sup>13</sup> represented the starting point for the development of the hypersampler's synthesis engine.

The typology of sound tracing developed for *Il grifo nelle perle nere* integrates the approach of Jehan with that of Jensesius, which identifies three types of sound tracing: "focusing on sound-production, timbral features or temporal development"<sup>14</sup>. The feature extraction process implemented here uses the third type of sound tracing.

### 2.1 Spectral noise gate – Amplitude bin extractor

The output signal from peak limiter unit is analyzed using a length  $N$  FFT of  $\tilde{x}_m$  to obtain the STFT at time  $m$ :

$$\tilde{x}'_m(e^{j\omega_k}) = \sum_{n=-N/2}^{N/2-1} \tilde{x}'_m(n)e^{-j\omega_k nT} \quad (1)$$

where  $\omega_k = 2\pi kf_s/N$ , and  $f_s = 1/T$  is the sampling rate in Hz. The STFT bin number is  $k$ .  $N = 512$ . Then each FFT bin  $\tilde{x}'_m(e^{j\omega_k})$  was converted from rectangular to polar form to get bin  $k$ 's instantaneous amplitude.

$$A_k(m) \triangleq |\tilde{x}'_m(e^{j\omega_k})| \quad (2)$$

Only the first 32 bins are used and in particular only the amplitudes of bins that exceed a threshold, in order to cut the residual nondeterministic components of the sound in addition to the deterministic harmonic components. The signal so obtained is then filtered using a second order low-pass filter so as to obtain a low-frequency control signal. That signal is finally 'converted' in Hertz multiplying it by an appropriate conversion factor and sent to the peak extractor unit which identifies the maximum value sent out to the synthesis units by means of the trigger command T-R which is controlled in real time.

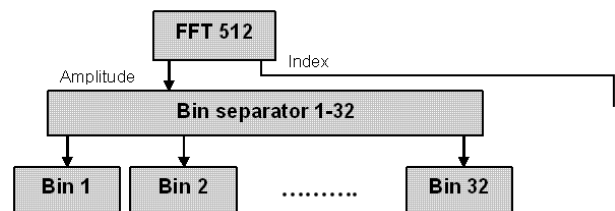

Figure 3. FFT analysis.

In Figure 4 the operations concerning the extraction of the parameter amplitude in one bin and its translation to a frequency scale are described.

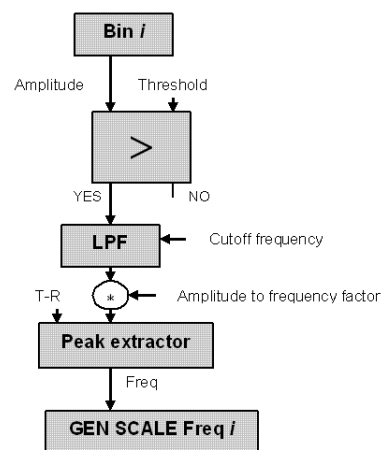

Figure 4. Translation of bin  $k$ 's instantaneous amplitude to a frequency scale.

The value of the parameter "threshold", that is the minimum amplitude value of single bins sent to the low-pass filter, must be so as to neatly cut the ground noise without compromising or altering the spectromorphological peculiarities of the analysed signal.

<sup>13</sup> T. Jehan, *op. cit.*, p.2.

<sup>14</sup> A. R. Jensesius, *op. cit.*, p. 86.

The value of the parameter *cutoff frequency* of the low-pass filter, is approximately set to 0.4 Hz.

The value of the parameter *amplitude to frequency factor*, that is the conversion factor, must be determined in a way that the maximum output values don't exceed the number 4000 and the minimum values never lower the value 20. The *Grain Generation Scale* is composed of the 32 frequency values so obtained.

## 2.2 Synthesis

The synthesis engine includes four clock-controlled Grain Generator Units, as shown in Figure 5.

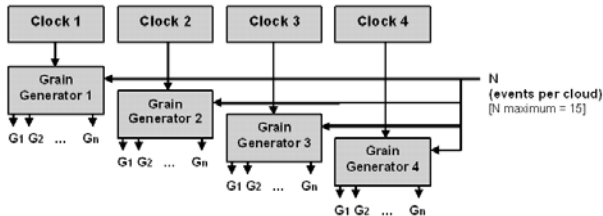

Figure 5. Synthesis module.

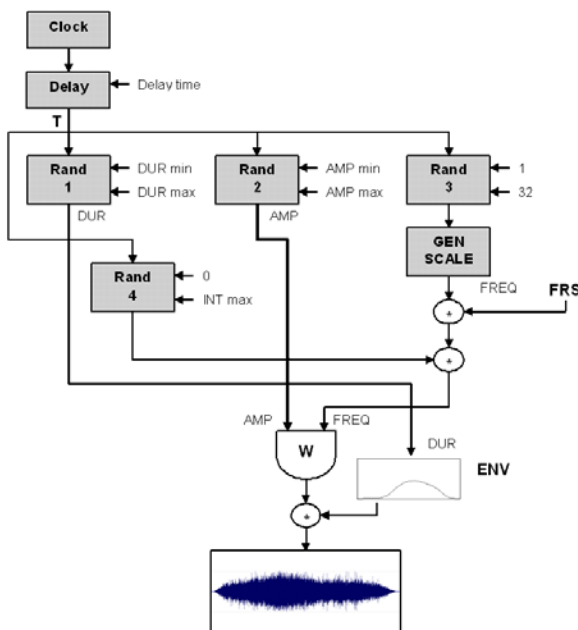

Figure 6. Synthesis engine Grain Generator.

The four *Synthesis* units require the four different waveforms (W) described below. In the case of implementation using Max/MSP it is suggested to use the object *gen* (linear b.p.f. wavetable generator) included in *PerColate – A collection of synthesis, signal processing, and video objects* by Dan Trueman (Princeton University) and R. Luke DuBois (Columbia University)<sup>15</sup> ported from real-time cmix, by Brad Garton and Dave Topper.

### Synthesis 1

GEN 7 (reads a list of amplitudes [0. ÷ 1.] interspersed with a number of points (in array numbers) between values and generates the function in time/amplitude pairs):

Number of points: 8192  
 Array: 0. 3072 1. 2048 1. 3072 0.

### Synthesis 2

GEN 10 (harmonic wavetable generator, reads a list of harmonic partial amplitudes and outputs index/amplitude pairs):

Number of points: 8192  
 Array: 1. 0.5 0.25 0.125 0.06 0.03 0.015 0.0075 0.00375 0.001875 0.0009 0.00045 0.000225

### Synthesis 3

GEN 24 (b.p.f. wavetable generator, reads a list of time/amplitude pairs and outputs index/amplitude pairs):

Number of points: 8192  
 Array: 0 0 1 1 2 0 3 -1 4 0

### Synthesis 4

GEN 9 (wavetable generator, reads a list of harmonic partial ratios, amplitudes, and phases [in triplets] and outputs index/amplitude pairs):

Number of points: 8192  
 Array: 1. 0.2 0. 8. 0.5 0. 8.01 0.5 0.2

Three different typologies of envelope (ENV) applicable in a mutually exclusive way to the grains generated by the four *Synthesis* units are required. The selection of an envelope is controlled in real time during the performance, with interpolation time from one envelope to another equal to 6 seconds. The three typologies of envelope are shown in Figure 7.

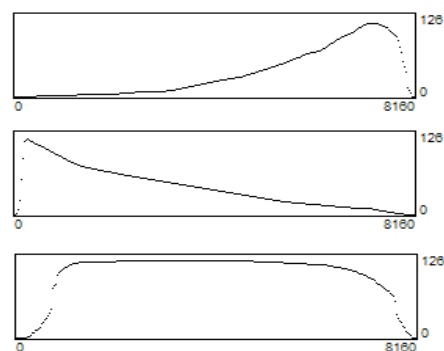

Figure 7. Envelopes which apply to the grains.

The module RAND 1 controls the parameter *grain duration*, by generation of random floating-point numbers comprised between the minimum value DUR min and the maximum value DUR max. The values of the two parameters are mutually related so to set a range of values which is controlled in real time during the performance by the live-electronics performer. The critical values of that range are: DUR min = 10ms, DUR max = 50ms [minimum values range]; DUR min = 3000ms, DUR max = 8000ms [maximum values range].

<sup>15</sup> <http://music.columbia.edu/percolate/>

The module RAND 2 controls the parameter *grain amplitude*, by generation of random floating-point numbers comprised between the minimum value *AMP min* and the maximum value *AMP max*. The values of the two parameters are mutually related so to set a range of values which is controlled in real time during the performance by the live-electronics performer. The critical values of that range and their comparison to the values of musical dynamics are described in Table 2.

The correlation curve between the parameters *DUR min* and *DUR max* in connection with the values assumed by a controller on a MIDI scale 1 ÷ 127 is described in the paragraph 2.3, as well as the curve which describes the course of the parameter *INT max* with relation to the values assumed by a controller on a MIDI scale 1 ÷ 127.

The module RAND 3 generates random integers between 1 and 32, determining the *Grain Generation Frequency* among the 32 possible frequencies generated by the module GEN SCALE which form the *Grain Generation Scale*. As specified above, the *Grain Generation Scale* must be changed many times during the performance using the command T-R (*FFT 512 – Spectral noise gate – Amplitude bin extractor*) controlled in real time, as well as the parameter *transposition interval*. The performer decides, according to his interpretation and musical sensibility, how many times the scale is changed during the performance and when, with relation to the musical score.

The module RAND 4 controls the variance of the parameter *transposition interval* expressed in semitones and cent, which causes a random variation of the grain frequency around the original value. The variations are comprised between 0 and the value *INT max*: *INT max* = 1 semitone, 27 cent.

The parameter *Frequency Range Shifting* (FRS) controls the transposition interval *n* (in Hertz) applied to the grains so that the grains' frequency is modified as indicated by the formula:

$$Freq_{fin} = (Freq_{init}) * n \quad (3)$$

The values assumed by the parameter *n* are controlled in real time during the performance. The curve which describes the course of the parameter *n* with relation to the values assumed by a controller on a MIDI scale 1 ÷ 127 is specified in the Figure 12.

The value of parameter *T* (*delay time*) of the Delay unit is comprised between 0 ms and 12700 ms, and is controlled in real time too.

The module Clock implements the following parameters and values.

- CT1 = clock time [ms]
- Vmin1 = minimum random generated number [int]
- Vmax1 = maximum random generated number [int]
- IT1 = interpolation time [ms]
- CT2 = clock time [ms]
- Vmin2 = minimum random generated number [int]
- Vmax2 = maximum random generated number [int]
- IT2 = interpolation time [ms]
- CT3 = clock time [ms]

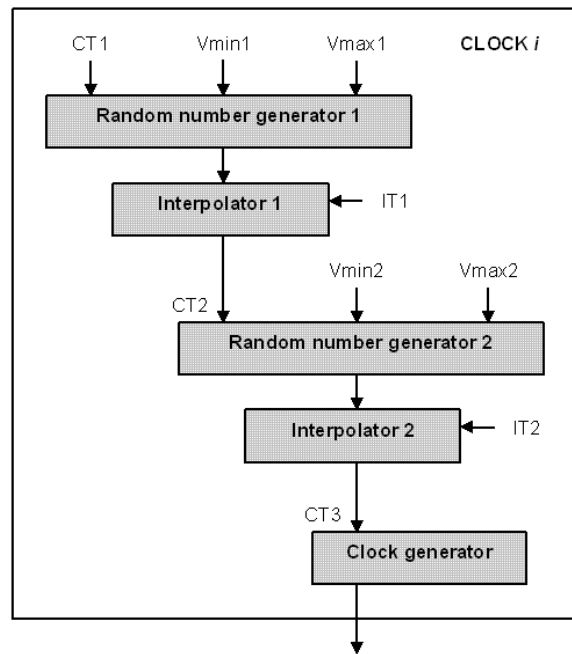

Figure 8. The module Clock.

	Clock			
	1	2	3	4
CT1	10000	8000	12000	10000
Vmin1	9000	7000	11000	2000
Vmax1	11000	9000	13000	11000
IT1	2500	2500	2500	2500
Vmin2	100	100	100	100
Vmax2	7000	5000	6000	4000
IT2	2500	3500	1800	3200

Table 1. Values for Clock's parameters

### 2.3 Grain amplitude, duration, detune and frequency shifting

In Table 2 are shown the nodal points for the mutually related variance curves of minimum and maximum values of the parameter *grain amplitude*. The same values, interpolated, are graphically represented in Figure 9.

Knob value [0÷127]	Min grain amplitude [0.÷1.]	Max grain amplitude [0.÷1.]	Dynamic range
0	0.01	0.05	ppp
32	0.0278	0.1062	ppp ÷ pp
64	0.1247	0.28	pp ÷ p
96	0.75	0.99	f ÷ fff
127	0.01	0.99	ppp ÷ fff

Table 2. Grain amplitude range values and dynamics.

Synthesis - grain amplitude range values

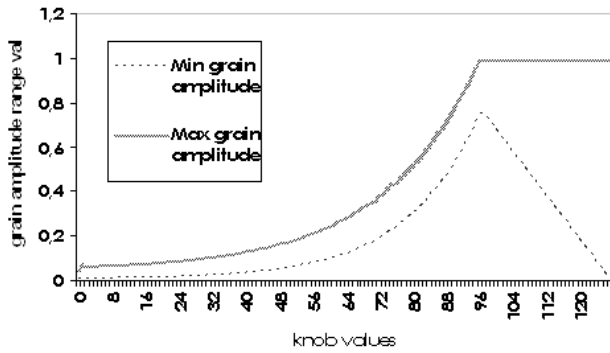

Figure 9. Variance curves for minimum and maximum values of parameter *grain amplitude*.

The variance curves for the mutually related minimum and maximum values of the parameter *grain duration* are graphically represented in Figure 10. On x-axis we have MIDI values [1 ÷ 127]; on y-axis we have the values of parameter *grain duration*.

Synthesis - grain duration range values

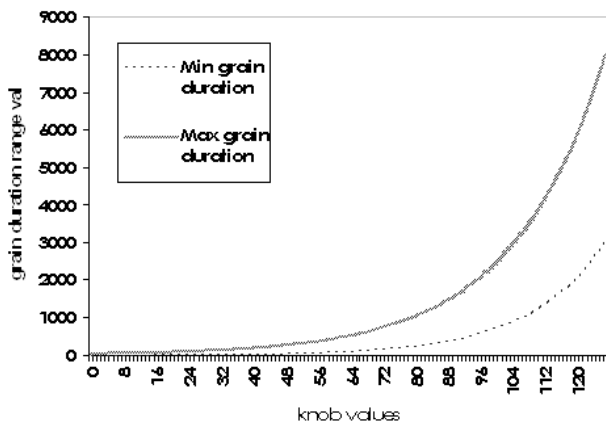

Figure 3. Variance curve for the minimum and maximum values of the parameter *grain duration*.

The variance curve of values assigned to the parameter *grain detune* are graphically represented in Figure 11. On x-axis we have MIDI values [1 ÷ 127]; on y-axis we have values of the parameter *grain detune*.

Synthesis - grain detune values

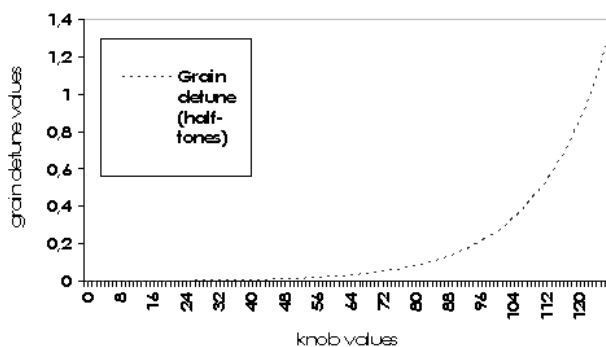

Figure 4. Variance curve for the values assigned to the parameter *grain detune*.

The variance curve for the values assigned to the parameter *grain frequency shifting* are graphically represented in Figure 12. On x-axis we have MIDI values [1 ÷ 127]; On y-axis we have values of the parameter *grain frequency shifting*.

Synthesis - grain frequency shifting values

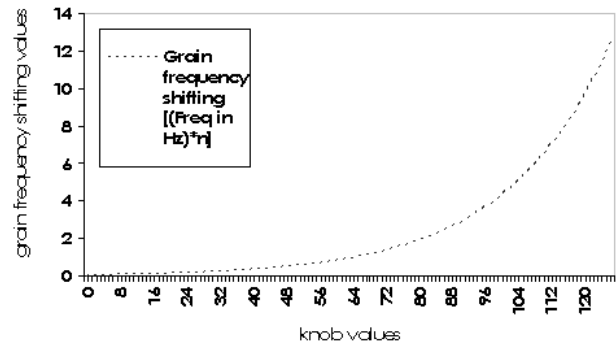

Figure 5. Variance curve for the values assigned to the parameter *grain frequency shifting*.

## 2.4 Parameters controlling

In Tables 3 e 4 it is shown the assignment of parameters to the knobs (Table 3) and to the keys (Table 4) of a master keyboard e.g. **EDIROL PCR1**, providing one possible performance configuration for *Il grifo nelle perle nere*.

Knob	Parameter name	Parameter range
1	Spat matrix 1,2 – step time	50÷5000 [ms]
2	Spat matrix 1,2 – ramp	0.01÷12.7 [multipl. factor]
3	Synthesis – grain amplitude	0.01÷1 [multipl. factor]
4	Synthesis – grain duration	10, 50÷3000, 8000 [ms]
5	Synthesis – grain detune	0÷1.27 [%]
6	Synthesis – grain frequency shifting	0÷12.7 [multipl. Factor]
7	Output spat matrix 1,2 / pitch transposers	100%, 0% ÷ 0%, 100%

Table 3. Knob assignment [EDIROL PCR1].

Key	Process name	
1	C1	send analysis peak frequencies to synthesis units 1-4
2	C#1	input signal – limiter out – synthesis out ON (5000 ms ramp)
3	D1	input signal – limiter out – synthesis out OFF (5000 ms ramp)
4	D#1	select envelope 1 (6000 ms ramp)
5	E1	select envelope 2 (6000 ms ramp)
6	F1	select envelope 3 (6000 ms ramp)
7	F#1	select 1 grain per cloud – close sound (less delay between grains)
8	G1	select 1 grain per cloud – distant sound (more delay between grains)

9	G#1	select 2 grains per cloud – close sound (less delay between grains)
10	A1	select 2 grains per cloud – distant sound (more delay between grains)
11	A#1	select 3 grains per cloud – close sound (less delay between grains)
12	B1	select 3 grains per cloud – distant sound (more delay between grains)
13	C2	start pitch transposers
14	C#2	stop pitch transposers
15	D2	start synthesis
16	D#2	stop synthesis

**Table 4.** Keys assignment [EDIROL PCR1].

### 3. DISCUSSION

In *Il grifo nelle perle nere* a virtual instrument is inserted on a traditional instrument, giving rise to a hybrid between mechanical and computer, using data extracted from the musical interpretation of the pianist to control an independent virtual system, which meets the requirements of a hyperinstrument and realizes the statement of Machover according to which the goal of a hyperinstrument would be “to produce music of unprecedented subtlety, complexity, richness, and expressive power that is intimately, but not obviously, linked to the original intent of the performer/composer”<sup>16</sup>. Machover’s approach towards “double” and “triple instruments”<sup>17</sup>, in which two or more people are playing a single hyperinstrument, is not unlike the one at the base of *Il grifo nelle perle nere*, where a “double instrument”, the hypersampler, is controlled, at different levels, by the pianist and by the keyboard performer: the first, by changing the intensity parameter through the instrumental dynamics, affects a number of parameters including the choice of the pitch scale from which the synthetic sounds are generated by the computer; these sounds, processed by convolution, are controlled in real time by the second, which in turn can change the number of sounds produced at the unit of time, their density, their positioning within the virtual space, providing the first performer a new musical material on which interact, in a continuous and fertile creative feedback mechanism, since double instrument performers “must relate their musical gestures not only to the resulting sound as in traditional instruments, but also to the gesture and sound of the other performer”<sup>18</sup>.

The choice of musical materials aimed to emphasize the elements submitted to the mapping allows the hyperin-

strument system to enhance its sensitivity to the most subtle variations of the pianist’s interpretation, and use that ability to amplify the performance, under the strict control of the two performers.

Consistently with Machover’s assertions about the importance of the conceptual simplicity of the interface, this system is easily understood by the performer, who has a chance to become aware about the specific relationship of causality (semi-deterministic and bound to the interaction with the live electronics performer) that binds his actions to the production of the sound output by the system and, through a period of practice, refine his performance.

In this way, the system is partially controllable by the instrumental performer, which can achieve a level of control over the music that is even greater than it has in general.

The computer does not play a part isolated. The performers have the opportunity to check the results and to take on more roles from a musical point of view, depending on the particular direction they decide to give the performance from time to time, while keeping unchanged the more general and macroscopic aspects of the musical result.

The relationship control / independence (between the two electronic performers) is mediated by the machine (the hypersampler), which assumes the role of *double instrument* formed by two performers that work together to control a complex instrument, each of which controlling only part of the final result.

In *Il grifo nelle perle nere*, the hypersampler is an organism with individuality and aimed at structural change in terms of perception of a pre-existing instrument (the piano) to obtain a *hybrid instrument* that is partly physical instrument and partly virtual, and includes that “partial and expected *unpredictability*”<sup>19</sup> which was mentioned earlier as a distinctive feature of each instrumental practice, traditional or contemporary.

This variability factor the level of influence of the piano on the electronic transformation / generation of sound is sometimes clear and direct, other times more indirect and mysterious, according to the particular filtering that intervene on the data in continuous variation.

The relationship between the pianist, the live electronics performer and the hypersampler takes place on several levels, through multidirectional and highly reconfigurable processes.

The hyperinstrument system is programmed so as to discern what data considered sensitive depending on the process and of its position in time, and then use this data, together with the choices made in real time by the live electronics performer (choices that can change this data), in connection with the interpretive choices of the pianist, which determine, in a flexible way, to a level of quality,

<sup>16</sup> T. Machover, *Hyperinstruments: A Progress Report*, p. 7.

<sup>17</sup> A double instrument is conceived for two musicians that play together on separate physical controllers (one of those can be an acoustic instrument) to breed a hybrid instrument “so that each musician can influence certain aspects of the music, but both players are required to perform in ensemble to create the entire musical result” [Machover, *op. cit.*, p. 27]. For example, in Machover’s *Towards the Center* the keyboard player controls the overall sound spectrum –the partials, the harmonic series, the spectromorphologic qualities of sound – while the percussionist controls the behavior of each partial, like a microscope where one observer acts on a smaller portion (controls more extended parts) while another observer acts on a greater portion (controls smaller parts, internal to the parts controlled by the other observer).

<sup>18</sup> T. Machover, *A Progress Report*, p. 28.

<sup>19</sup> M. Marinoni, *Comporre per gli iperstrumenti. Il sistema-iperstrumento come agente intermediatore tra l’esecutore strumentale e i processi di trasformazione/generazione del suono*, Ph.D. Thesis, Conservatorio di Venezia, 2007, p. 34.

choice of materials and their positioning in the process of transformation / generation.

The second order 1:1 mapping is implemented via software (the environment has been entirely developed in Max/MSP) and the feature extraction process which is implemented on the traditional instrument does not imply structural change: this increases the level of reproducibility, not bound to the context or the availability of specific technologies, however, placing a question of theoretical order: is the difference between what we call generally live-electronics and what we call a hyperinstrument linked to the use of technologies such as sensors etc., as Machover and the MIT researchers seem to say, or is it a difference of higher order (multiple instruments, different in nature, acoustic and electronic, with specific performers who play performances interconnected, according to Weinberg's theory, which form a single hybrid instrument, equipped with its own identity, qualitatively different from the sum of the identities of the individual instruments involved: the hyperinstrument system) and the hyperinstruments are but a subset of the broader category of live-electronics?

#### 4. CONCLUSIONS AND FUTURE WORK

Assuming with Benzon that music is “a medium though which individual brains are coupled together in shared activity”<sup>20</sup>, the hypersampler can be considered as a basic Interconnected Musical Network (composed of two units), that is a “live performance system that allow players to influence, share, and shape each other's music in real-time”<sup>21</sup>, being also a feature extraction driven double instrument in which an acoustic instrument is “complemented by delicate electronics played and transformed by a keyboard-with-laptop [...] creating shifting textures that ‘fuse’ the various instrumental lines”<sup>22</sup>.

From the musician's perspective, the hypersampler behaves intuitively and predictably. The control features of the traditional instrument are used “as input for the model of a different instrument”<sup>23</sup> that is the hypersampler system and the resulting hybrid double instrument is perceptually meaningful. Future work will include algorithms that extract more control features and the extension of this approach to different instruments such as flute and violin.

#### 5. REFERENCES

- [1] W. L. Benzon, *Beethoven's Anvil: Music in Mind and Culture*. New York, Basic Books, 2001.
- [2] J. Bullock, *Implementing audio feature extraction in live electronic music*, Ph.D. Thesis, Birmingham Conservatoire, Birmingham City University, 2008.
- [3] T. Jehan, *Perceptual synthesis engine: An audio-driven timbre generator*. Master's thesis, Massachusetts Institute of Technology, 2001.
- [4] A. R. Jensenius, *Action — sound. Developing methods and tools to study music-related body movement*. Ph.D. thesis, Department of Musicology, University of Oslo, Oslo, Norway, 2007.
- [5] T. Machover, “Dreaming a New Music”, *Chamber Music*, Vol. 23 No 5 October 2006, pp. 46–54.
- [6] T. Machover, *Hyperinstruments: A Progress Report*. Cambridge: MIT – Media Lab, 1992.
- [7] M. Marinoni, *Comporre per gli iperstrumenti. Il sistema-iperstrumento come agente intermediatore tra l'esecutore strumentale e i processi di trasformazione/generazione del suono*. Ph.D. Thesis, Conservatorio di Venezia, 2007.
- [8] M. Marinoni, *Il grifo nelle perle nere*. Score, Ars Publica Edizioni Musicali AP 00403M, piazza S. Valentino, 12 – 33030 Camino al Tagliamento UD – Italy, 2009.
- [9] R. Rowe, *Interactive music systems: machine listening and composing*. Cambridge, MA, USA: MIT Press, 1992.

<sup>20</sup> W. L. Benzon, *Beethoven's Anvil: Music in Mind and Culture*, Oxford University Press, 2002.

<sup>21</sup> G. Weinberg, *op. cit.*, p. 4.

<sup>22</sup> T. Machover, *Dreaming a New Music*, in “Chamber Music”, Vol. 23 No 5 October 2006, pp. 46–54, p. 50.

<sup>23</sup> T. Jehan, *op. cit.*, p. 7.